

T1
TORNILLO

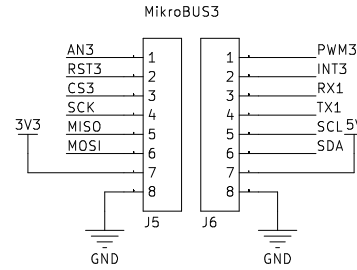

T2
TORNILLO

T3
TORNILLO

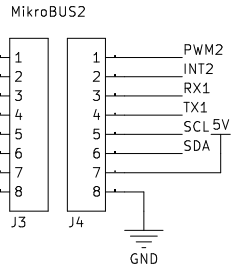
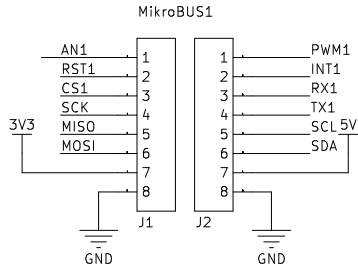
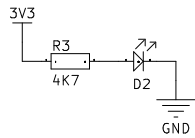
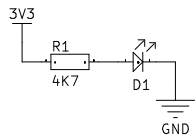

T4
TORNILLO

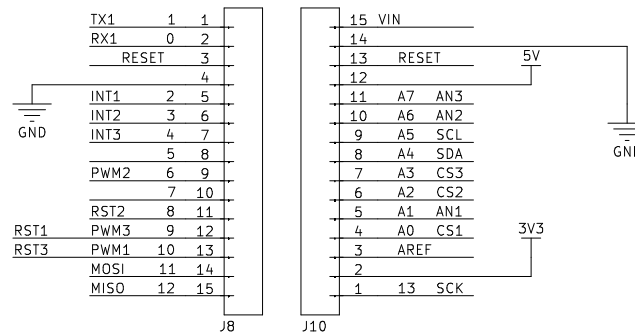
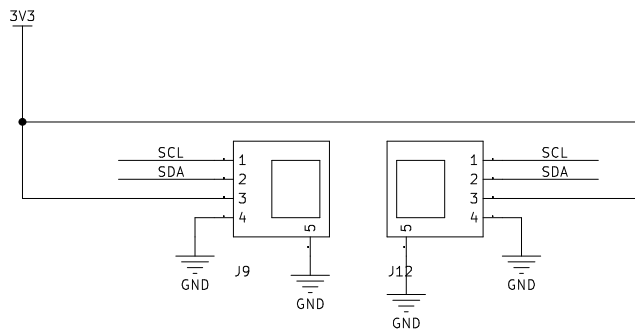
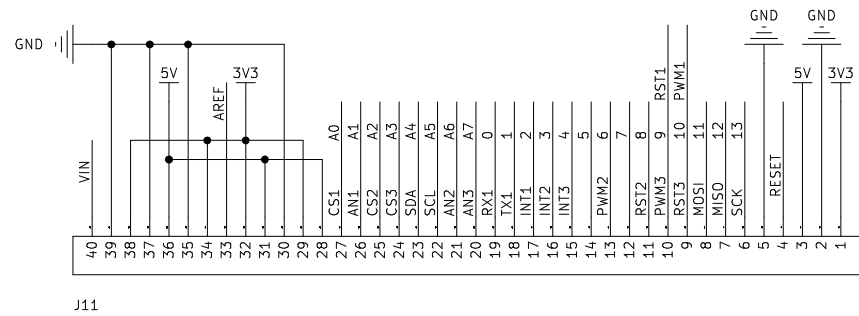

www.microside.com/xide

Microside Technology no asume responsabilidad alguna por errores o inexactitudes que puedan aparecer en el presente documento. Las especificaciones y la información contenidas en el presente esquemático están sujetas a cambios en cualquier momento sin previo aviso.

Title: X-BOARD Arduino Nano 33

XB02
MICROSIDE TECHNOLOGY

Rev: R1
Date: 2022-06-14

X | B

